

# GRB mixers<sup>®</sup>

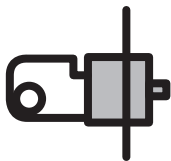

instrucciones monomandos empotrar  
built-in mixer instructions  
instructions mitigeur à encastrer

**GRB mixers<sup>®</sup>**

Alaún 19, Pla-Za

50197 Zaragoza (Spain)

[www.grbmixers.com](http://www.grbmixers.com) · [info@grb.es](mailto:info@grb.es)

040764.99



20 00900 19830 0



GRB is a Spanish Certified Product. CEE



## Aspectos generales

Installation and assembly · Installation et montage



**Primero, purgar las tuberías**

First, drain pipes

Tout d'abord, purger la tuyauterie

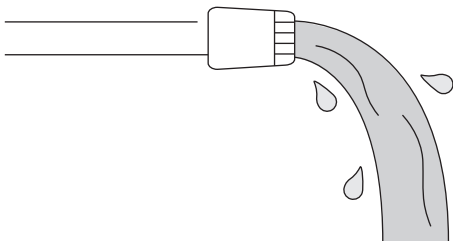

**BAR 1**  
MIN

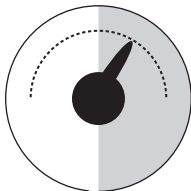

**5 BAR**  
MIN

**RECOMMENDED**



# Instalación y montaje

Installation and assembly · Installation et montage

## 1 Dimensiones · Dimensions · Mesures

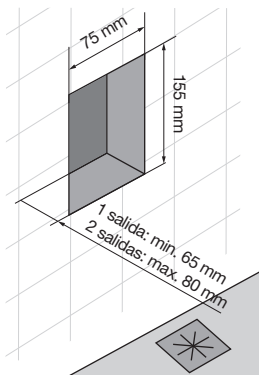

1 Salida / 1 way / 1 voie

Salida de agua  
water outlet  
sortie d'eau

①



—



FRÍA  
COLD  
FROID



CALIENTE  
HOT  
CHAUDE

+

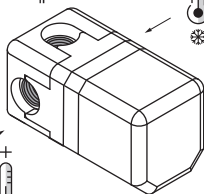

**ATENCIÓN:** salida de agua  
hacia arriba.

ATTENTION: upper outlet  
ATTENTION: arrivée d'eau en  
haut

2 Salidas / 2 ways / 2 voies



Salida de agua  
water outlet  
sortie d'eau

①

②

Salida de agua  
water outlet  
sortie d'eau

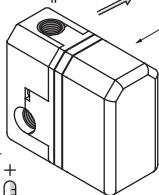

CALIENTE  
HOT  
CHAUDE

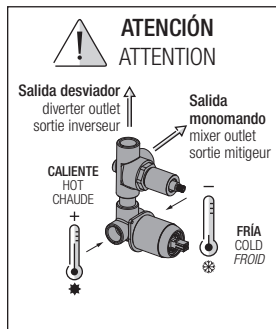

2 Max. Min.



MAX.-MIN.

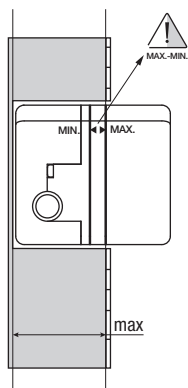
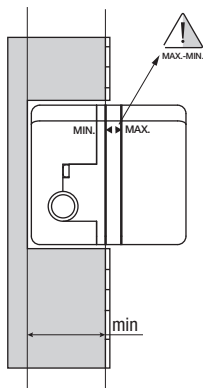

**3** Nivelar · Level · Nivelez

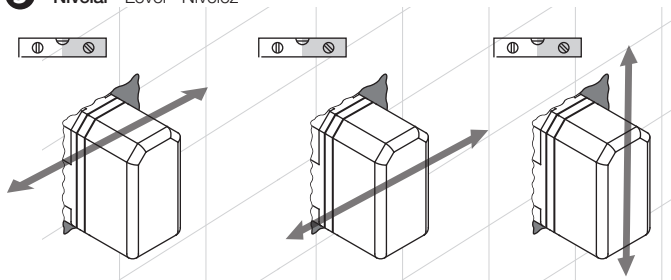

**4** Alicatar · Shape · Carrez

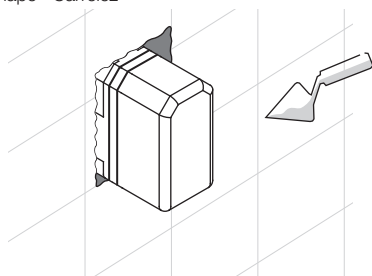

**5** Retirar la espuma · Remove the foam · Retirez la protection

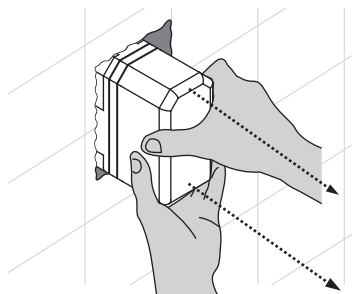

## 6 Colocación final · Colocación final · Colocación final

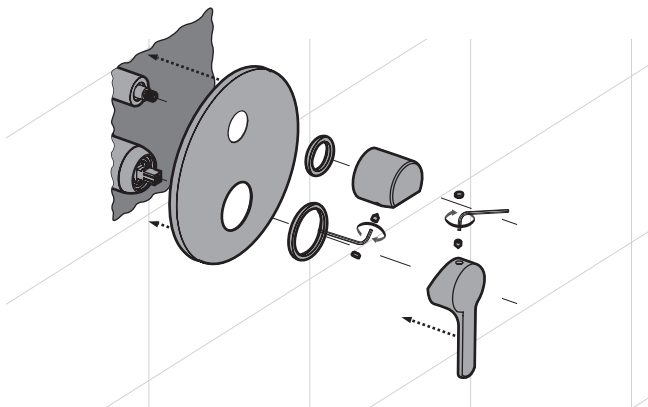

### Limpieza y mantenimiento

Maintenance and cleaning · Nettoyage et maintenance



Clorhidric acid



Formic acid



Acetic acid

